



## Description

### JMT N-channel Enhancement Mode Power MOSFET

#### Features

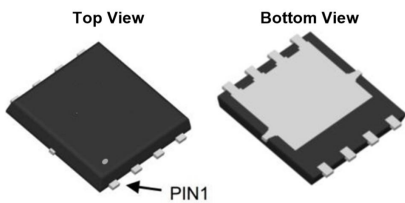
- 60V, 70A  
 $R_{DS(ON)} < 5.8m\Omega @ V_{GS} = 10V$
- Advanced Trench Technology
- Provide Excellent  $R_{DS(ON)}$  and Low Gate Charge
- Lead Free

#### Application

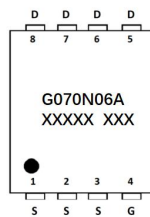
- Load Switch
- PWM Application
- Power Management



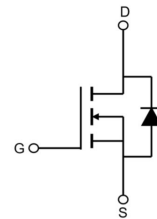
*100% UIS TESTED!*  
*100%  $\Delta V_{ds}$  TESTED!*



PDFN5x6-8L



Marking and pin Assignment



Schematic Diagram

## Package Marking and Ordering Information

Device Marking	Device	Outline	Package	Reel Size	Reel (pcs)	Per Carton (pcs)
G070N06A	JMTG070N06A	TAPING	PDFN5x6-8L	13"	5000	50000

## Absolute Maximum Ratings ( $T_C=25^\circ C$ unless otherwise specified)

Symbol	Parameter	Max.	Units
$V_{DSS}$	Drain-Source Voltage	60	V
$V_{GSS}$	Gate-Source Voltage	$\pm 20$	V
$I_D$	Continuous Drain Current	$T_C = 25^\circ C$	70
		$T_C = 100^\circ C$	45.5
$I_{DM}$	Pulsed Drain Current <sup>note1</sup>	280	A
EAS	Single Pulsed Avalanche Energy <sup>note2</sup>	182	mJ
$P_D$	Power Dissipation	$T_C = 25^\circ C$	50
$R_{\theta JC}$	Thermal Resistance, Junction to Case	2.5	$^\circ C/W$
$T_J, T_{STG}$	Operating and Storage Temperature Range	-55 to +150	$^\circ C$



## Electrical Characteristics (T<sub>J</sub>=25°C unless otherwise specified)

Symbol	Parameter	Test Condition	Min.	Typ.	Max.	Units
<b>Off Characteristics</b>						
V <sub>(BR)DSS</sub>	Drain-Source Breakdown Voltage	V <sub>GS</sub> =0V, I <sub>D</sub> =250μA	60	-	-	V
I <sub>DSS</sub>	Zero Gate Voltage Drain Current	V <sub>DS</sub> =60V, V <sub>GS</sub> =0V,	-	-	1.0	μA
I <sub>GSS</sub>	Gate to Body Leakage Current	V <sub>DS</sub> =0V, V <sub>GS</sub> =±20V	-	-	±100	nA
<b>On Characteristics</b>						
V <sub>GS(th)</sub>	Gate Threshold Voltage	V <sub>DS</sub> =V <sub>GS</sub> , I <sub>D</sub> =250μA	2	-	4	V
R <sub>DS(on)</sub>	Static Drain-Source on-Resistance <small>note3</small>	V <sub>GS</sub> =10V, I <sub>D</sub> =30A	-	4.6	5.8	mΩ
<b>Dynamic Characteristics</b>						
C <sub>iss</sub>	Input Capacitance	V <sub>DS</sub> =25V, V <sub>GS</sub> =0V, f=1.0MHz	-	3782	-	pF
C <sub>oss</sub>	Output Capacitance		-	297	-	pF
C <sub>rss</sub>	Reverse Transfer Capacitance		-	218	-	pF
Q <sub>g</sub>	Total Gate Charge	V <sub>DD</sub> =30V, I <sub>D</sub> =30A, V <sub>GS</sub> =10V	-	77	-	nC
Q <sub>gs</sub>	Gate-Source Charge		-	21	-	nC
Q <sub>gd</sub>	Gate-Drain("Miller") Charge		-	24	-	nC
<b>Switching Characteristics</b>						
t <sub>d(on)</sub>	Turn-on Delay Time	V <sub>DD</sub> =30V, I <sub>D</sub> =30A, R <sub>GEN</sub> =1.8Ω, V <sub>GS</sub> =10V	-	18	-	ns
t <sub>r</sub>	Turn-on Rise Time		-	88	-	ns
t <sub>d(off)</sub>	Turn-off Delay Time		-	37	-	ns
t <sub>f</sub>	Turn-off Fall Time		-	85	-	ns
<b>Drain-Source Diode Characteristics and Maximum Ratings</b>						
I <sub>S</sub>	Maximum Continuous Drain to Source Diode Forward Current		-	-	70	A
I <sub>SM</sub>	Maximum Pulsed Drain to Source Diode Forward Current		-	-	280	A
V <sub>SD</sub>	Drain to Source Diode Forward Voltage	V <sub>GS</sub> =0V, I <sub>S</sub> =30A	-	-	1.2	V
trr	Body Diode Reverse Recovery Time	I <sub>F</sub> =30A, di/dt=100A/μs	-	25	-	ns
Q <sub>rr</sub>	Body Diode Reverse Recovery Charge		-	29	-	nC

Notes:1. Repetitive Rating: Pulse Width Limited by Maximum Junction Temperature

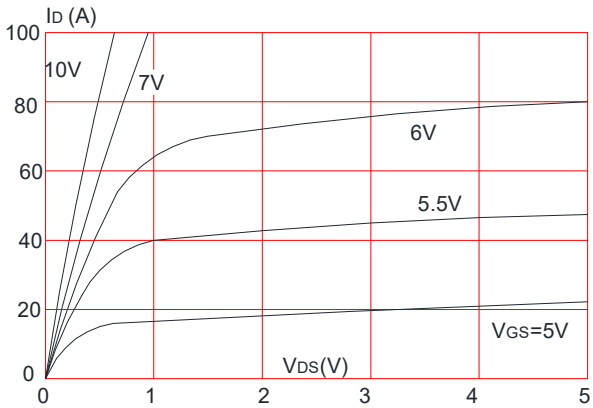
2. EAS condition : Starting T<sub>J</sub>=25°C, V<sub>DD</sub>=30V, V<sub>GS</sub>=10V, L=0.5mH, R<sub>g</sub>=25Ω, I<sub>AS</sub>=27A

3. Pulse Test: Pulse Width≤300μs, Duty Cycle≤0.5%

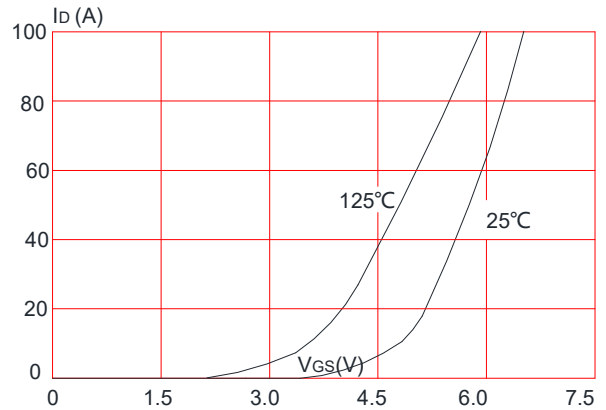


## Typical Performance Characteristics

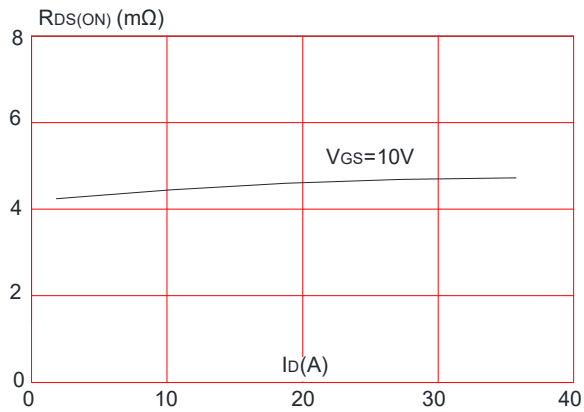
**Figure 1: Output Characteristics**



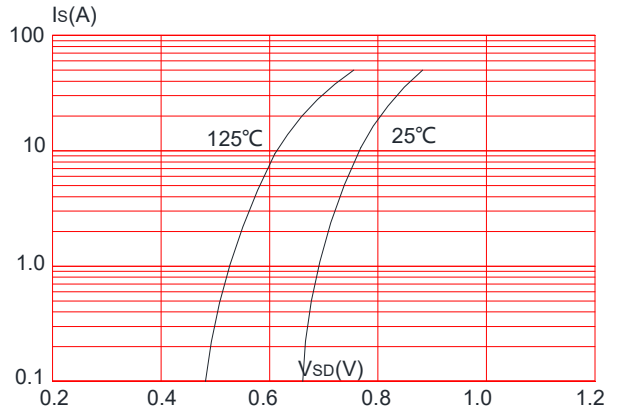
**Figure 2: Typical Transfer Characteristics**



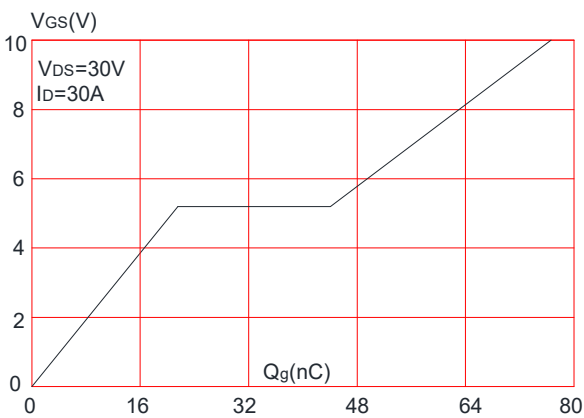
**Figure 3: On-resistance vs. Drain Current**



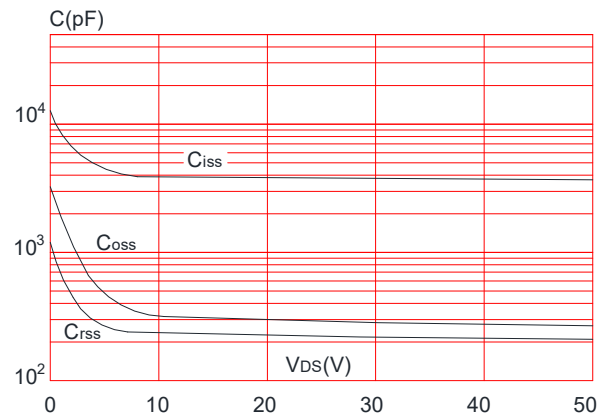
**Figure 4: Body Diode Characteristics**



**Figure 5: Gate Charge Characteristics**

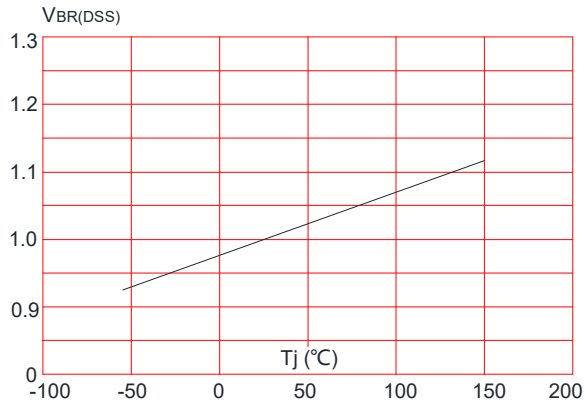


**Figure 6: Capacitance Characteristics**

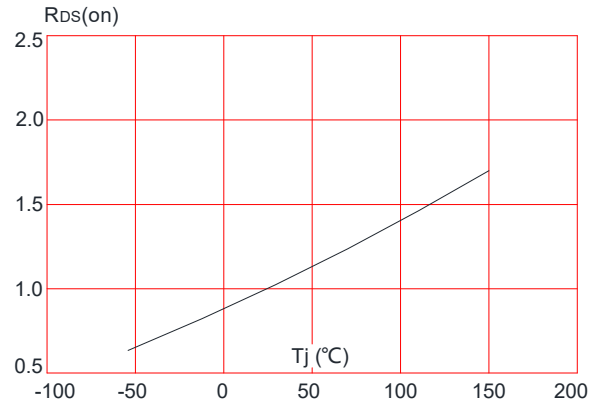




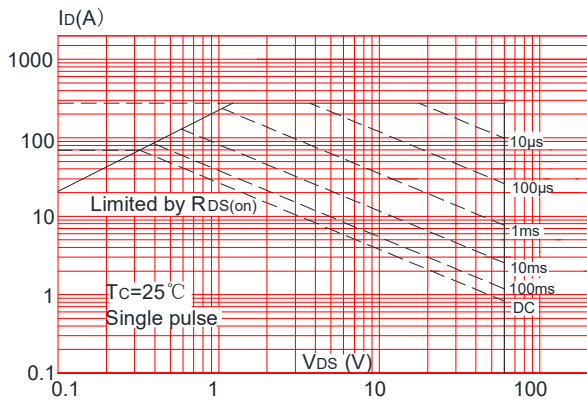
**Figure 7:** Normalized Breakdown Voltage vs. Junction Temperature



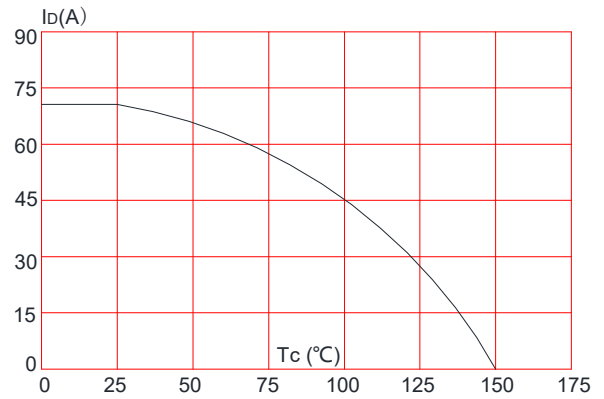
**Figure 8:** Normalized on Resistance vs. Junction Temperature



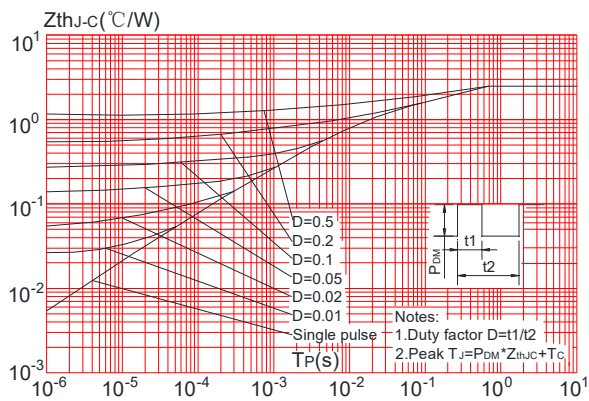
**Figure 9:** Maximum Safe Operating Area



**Figure 10:** Maximum Continuous Drain Current vs. Case Temperature



**Figure 11:** Maximum Effective Transient Thermal Impedance, Junction-to-Case



## Test Circuit

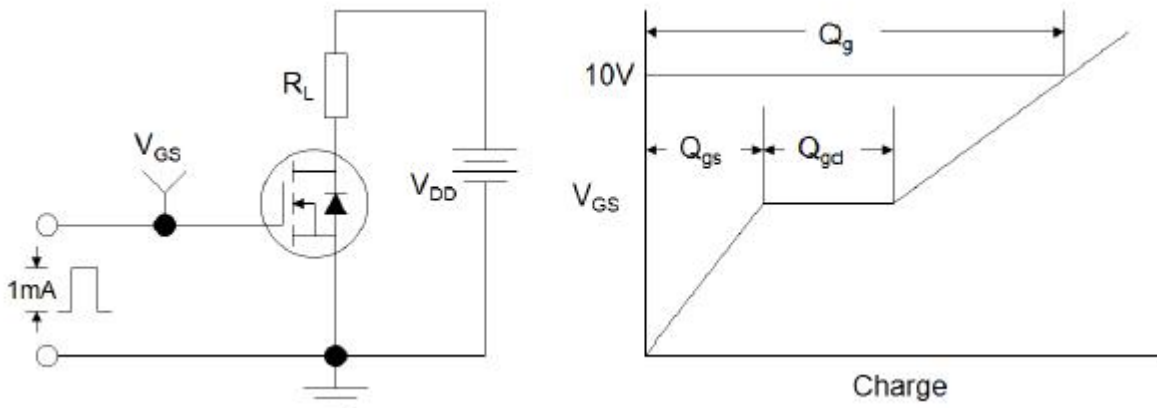


Figure1:Gate Charge Test Circuit & Waveform

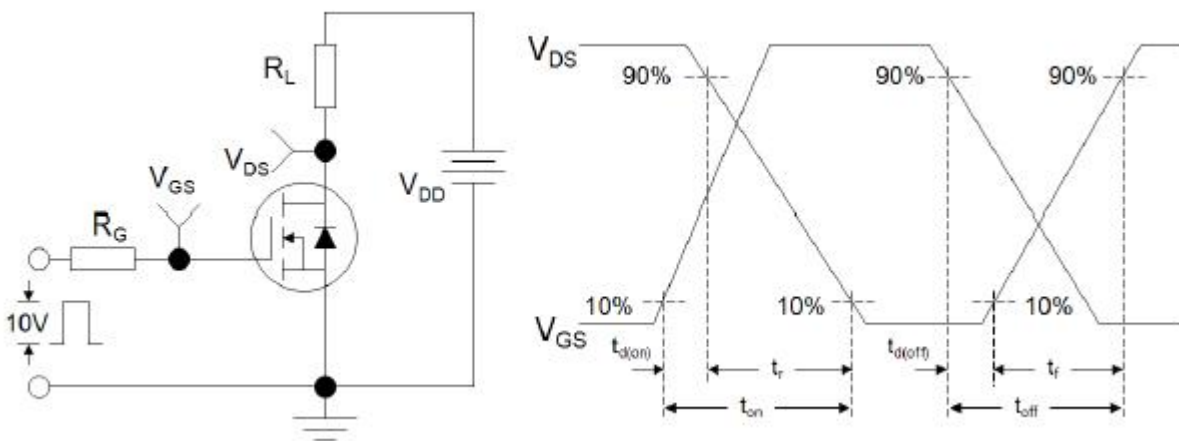


Figure 2: Resistive Switching Test Circuit & Waveforms

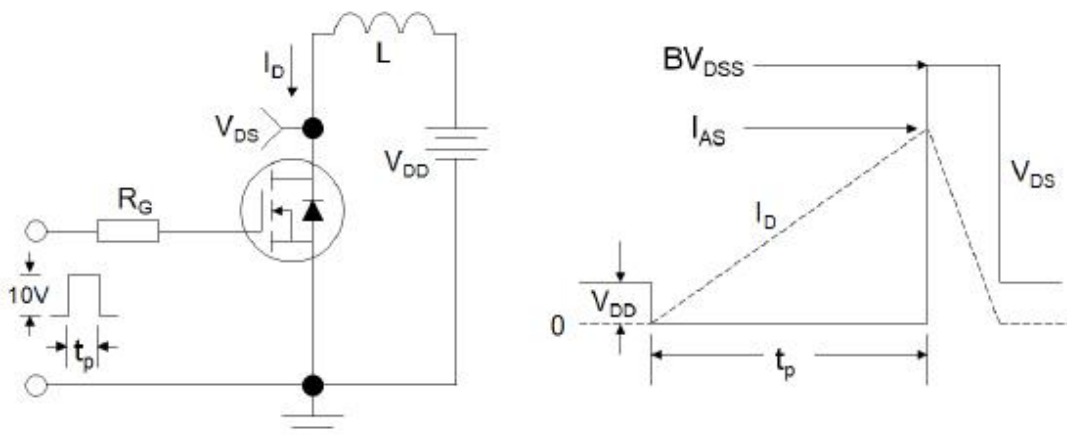
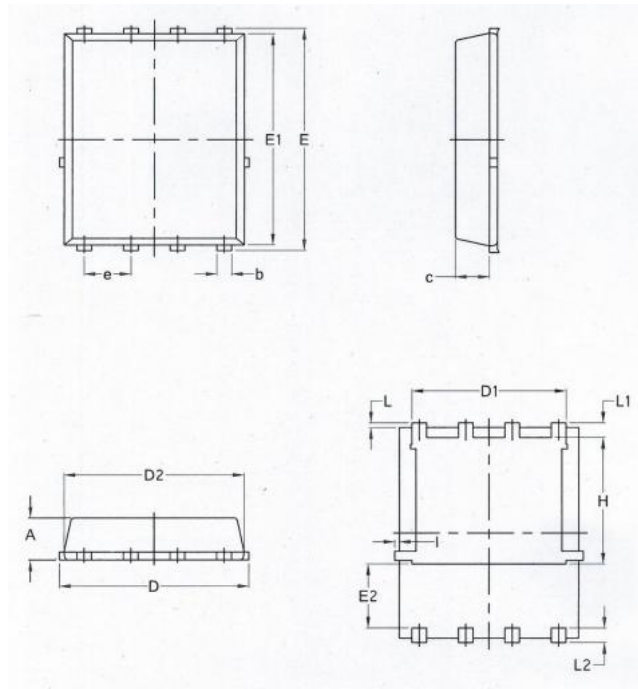


Figure 3:Unclamped Inductive Switching Test Circuit & Waveforms

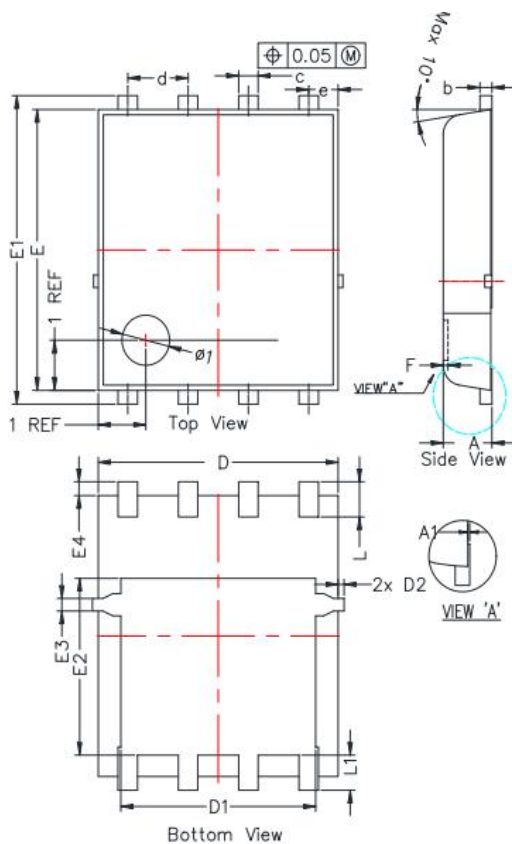


## Package Mechanical Data-PDFN5x6-8L-Type A



SYMBOL	COMMON			
	MM		INCH	
	MIN.	MAX.	MIN.	MAX.
A	1.03	1.17	0.0406	0.0461
b	0.34	0.48	0.0134	0.0189
c	0.824	0.970	0.0324	0.0382
△ D	4.80	5.40	0.1890	0.2126
△ D1	4.11	4.31	0.1618	0.1697
△ D2	4.80	5.00	0.1890	0.1969
E	5.95	6.15	0.2343	0.2421
E1	5.65	5.85	0.2224	0.2303
E2	1.60	—	0.0630	—
e	1.27 BSC		0.05 BSC	
△ L	0.05	0.25	0.0020	0.0098
L1	0.38	0.50	0.0150	0.0197
L2	0.38	0.50	0.0150	0.0197
△ H	3.30	3.50	0.1299	0.1378
I	—	0.18	—	0.0070

## Package Mechanical Data-PDFN5x6-8L-Type B




SYMBOLS	DIMENSION IN MM			DIMENSION IN INCHES		
	MIN	NOM	MAX	MIN	NOM	MAX
* A	0.900	1.000	1.100	0.035	0.039	0.043
A1	0.000	---	0.050	0.000	---	0.002
b	0.246	0.254	0.312	0.010	0.010	0.012
* c	0.310	0.410	0.510	0.012	0.016	0.020
d	1.27 BSC			0.050 BSC		
* D	4.950	5.050	5.150	0.195	0.199	0.203
D1	4.000	4.100	4.200	0.157	0.161	0.165
* D2	---	---	0.125	---	---	0.005
e	0.62 BSC			0.024 BSC		
* E	5.500	5.600	5.700	0.217	0.220	0.224
* E1	6.050	6.150	6.250	0.238	0.242	0.246
E2	3.425	3.525	3.625	0.135	0.139	0.143
E3	0.150	0.250	0.350	0.006	0.010	0.014
* E4	0.175	0.275	0.375	0.007	0.011	0.015
F	-	-	0.100	-	-	0.004
* L	0.500	0.600	0.700	0.02	0.02	0.03
L1	0.600	0.700	0.800	0.02	0.03	0.03



Information furnished in this document is believed to be accurate and reliable. However, Jiangsu JieJie Microelectronics Co.,Ltd assumes no responsibility for the consequences of use without consideration for such information nor use beyond it.

Information mentioned in this document is subject to change without notice, apart from that when an agreement is signed, Jiangsu JieJie complies with the agreement.

Products and information provided in this document have no infringement of patents. Jiangsu JieJie assumes no responsibility for any infringement of other rights of third parties which may result from the use of such products and information.

 is a registered trademark of Jiangsu JieJie Microelectronics Co.,Ltd.  
Copyright ©2022 Jiangsu JieJie Microelectronics Co.,Ltd. Printed All rights reserved.